

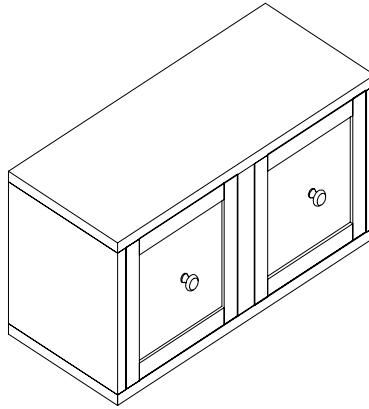

B-Cubed 3402 Door - Cube Double (Pair)





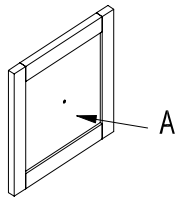

Thank you for purchasing our products. Assembly of this product requires a phillips screwdriver.

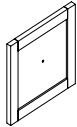
Lay out parts on a non-abrasive surface to avoid scratching finish.



NO.	DRAWING	DESCRIPTION	Q'TY
A		DOOR	2

NO.	DRAWING	DESCRIPTION	Q'TY
B		KNOB	2
C		KNOB SCREW	2
D		HINGE SCREWS	16
F		HINGES	4

Note: The Door - Cube - Double is an optional set of doors that can be put on a 3202 Cube Double or 3105 Base - Double.

STEP 1
Identify and count all parts using diagram above.

STEP 2
Identify and count all hardware.

STEP 3

Insert Hinge (F) into pre-drilled holes on back of Door (A) - two places. Secure hinges using screws (D) in pre-drilled pilot holes in door - 4 places. Attached door to Cube End by aligning screws thru the hinge mounting plate into pre-drilled pilot holes in the Cube End. Tighten all screws. Repeat above step for second door. Note: Doors may require adjustment for proper fit. Hinge is designed to allow for some adjustment.

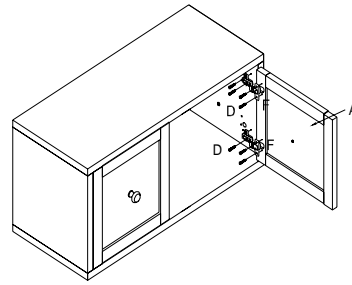

STEP 4

Attach Knob (B) to Door (A) using knob Screw (C)

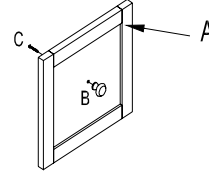

STEP 5

The Cube - Double 3202 or Base - Double 3105 w/ optional doors is now complete. The Cube - Double w/ doors can be used as a stand alone piece or one of the cubes within a stack-a-ble configuration. Base - Double w/ doors can be used as a stand alone piece or the base of a stack-a-ble configuration.

