









## **Assembly Sheet Low Loft**

Replacement parts can be obtained from any Bolton Furniture authorized dealer



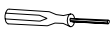





249 Professional Drive, Morrisville, VT  
Phone: 802-888-7974  
Fax: 802-888-3668  
Web Site: [www.boltonfurniture.biz](http://www.boltonfurniture.biz)



## PARTS LIST

### Ladder & Guardrail Parts List

NO.	Drawing	Description	Qty.
A		Ladder	1
B		20mm wood screw	6
C		Hook	2
D		50mm Hex Bolt	3
E		M6 Hex Wrench	1
F		1/2 Front Guardrail	1
G		Back Guardrail	1
H		30mm wood screw	4

### Low Loft Parts List

NO.	Drawing	Description	Qty.
C		80mm Hex Bolt	4
D		Cross Dowel	4
E		M8 Hex Wrench	1
F		M8 Insert	4
G		Headless Rod	4
H		Mushroom Plug	12
I		M6 Hex Wrench	1
J		60mm Hex Bolt	6
K		65mm Hex Bolt	2

NO.	Drawing	Description	Qty.
A		Leg Extension	4
B		Back Support Rail	1
*		Front Support Rail	2

**Low Loft Assembly: Two people recommended for this assembly.**

#### Step 1

Open all boxes and verify that all parts are included.

#### Step 2 - Install Threaded Inserts

Un-pack the Headboard and Footboard from bed box. Using Hex Wrench (E) Install Threaded Insert (F) into pre-drilled holes on bottom edge of Headboard and Footboard Bed Posts (4 places). Make sure the inserts are at least 1/8" below the surface. SEE DIAGRAM

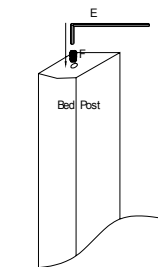

### Step 3

Assemble bed per instructions included with bed.

### Step 4 - Install Headless Rod

Thread Headless Rod (G) into threaded insert in Leg Extension (A) - 4 places. Make sure Headless Rod is threaded in at least 1/4" into insert in Leg Extension (A).

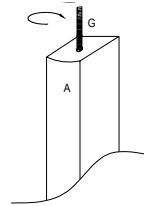

### Step 5 - Attach Leg Extensions

Lay assembled bed on its side - with counter sunk holes facing out make sure profile on the Leg Extensions match the profile on Bed Post. Attach 4 Leg Extensions (A) to Bed Post by threading headless rod into insert in bottom edge of Bed Post. Secure tightly. At this time Set bed up-right on 4 legs.

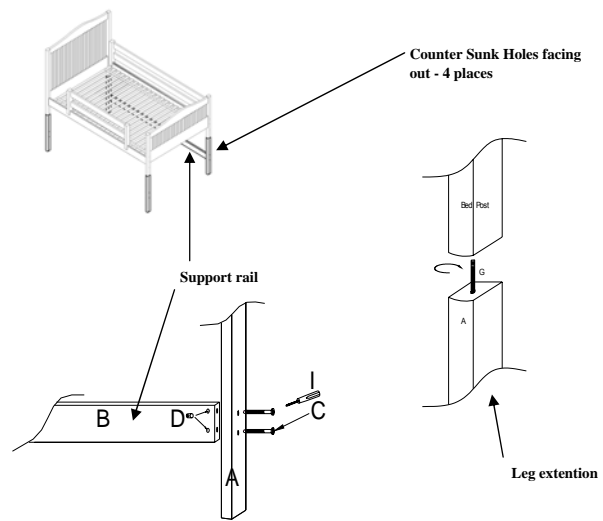

**Attach Support Rail** - Attach Back Support Rail (B) to back Leg Extensions using using 80 MM Hex Bolt (C) and Cross Dowel (D). Insert the Cross Dowels into pre-drilled holes in Back Support Rail - Align thru holes in Leg Extensions to pre-drilled holes in edge of Back Support Rail. Thread Hex Bolt into Cross Dowel. Tighten using Hex Srench (I).

### Step 6 - Attach Long Guardrail

Determine side of bed you want the long guardrail on. Position the long guardrail over siderail (you may need to loosen bed bolts)

Secure Long Gardrail to footboard end of bed using 50 MM Bed Bolt (D). Tighten with Hex Wrench (E). Next attach long guardrail to inside of side rails using 30 MM wood screw (H) - 2 places

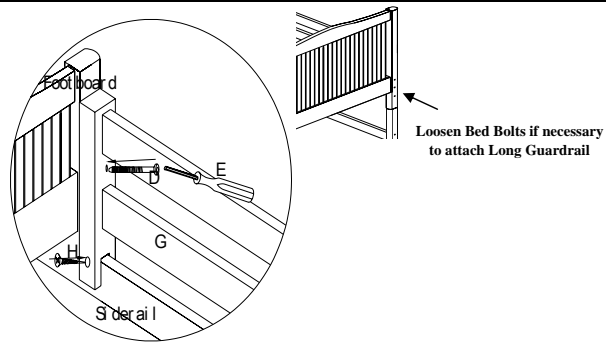

### Step 7 - Attach Ladder Hooks

Attach Hook (C) to Ladder (A) using 20 MM Wood Screws (B) - 2 places. Secure tight.

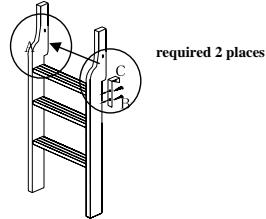

### Step 8 - Attach Ladder and Short Guardrail

Position the Ladder Hooks over the side rail on footboard end of bed and the short guardrail over the side rail. Secure the Ladder to bed end and short guardrail using 50 MM Hex Bolt (D) - 2 places.

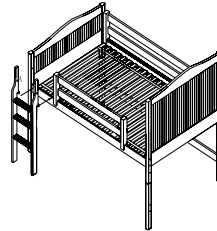

Using 20 MM Wood Screw (B) secure ladder hooks to inside of siderail.

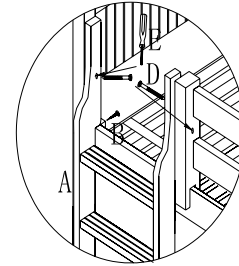
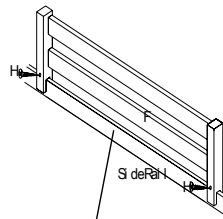

Using 20 MM Wood Screw (B) secure short guardrail to inside of siderail.

Inside of siderail - Cleat side

### Step 9 - Attach Front Support Rails

The Front Support Rail can be attached to the inside (Illustration A) or outside (Illustration B) of you Low Loft Configuration.

**Inside** - Attach Front Support Rail by inserting Hex Bolt "J" into thru hole in bed post and thru holes in leg extensions - thread into inserts in Front Support Rail. Tighten using M6 hex wrench (See Illustration A)

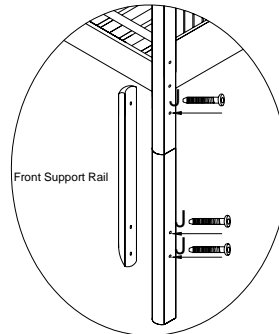

Illustration A (Inside)

**Outside** - Attach Front Support Rail by inserting Hex Bolt "k" into thru hole in bed post and inserting Hex Bolt "J" into holes in leg extensions. Thread into inserts in Front Support Rail. Tighten using M6 hex wrench (See Illustration B)

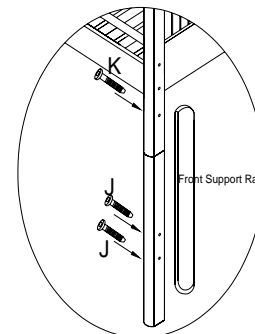
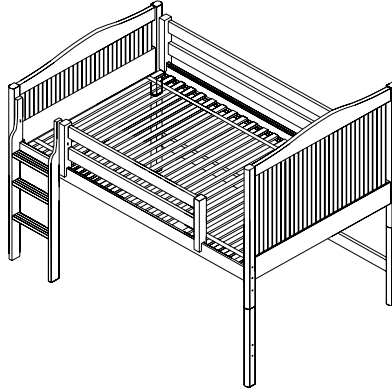

Illustration B (Outside)

**NOTE:** The Front Support Rail must be attached on the outside of Low Loft Assembly when using a Mission 7 Drawer Double Dresser under the Low Loft Configurations.

**You are now ready to add Tent Fabric or cases to your Low Loft Configurations**



**Safety Warnings:**

- 1) Follow the information on the warning label attached to the upper bunk end structure. Do not remove this label.
- 2) Always use the recommended size mattress to help prevent the likelihood of entrapment or falls. Use a mattress which is 75" long and 38 1/2" wide on the top bunk.
- 3) Always use the recommended size mattress to help prevent the likelihood of entrapment or falls. Use a mattress which is 75" long and 53 1/2" wide on the lower bed (full size).
- 4) Surface of mattress must be at least 5 inches below the upper edge of the guard rails. Ensure thickness of mattress and foundation combined does not exceed 8".
- 5) Do not allow children under 6 years of age to use the upper bunk.
- 6) Prohibit more than one person on the upper bunk.
- 7) Periodically check to ensure that the guard rails, ladder, and other components are in their proper position, free from damage, and that all connectors are tight.
- 8) Do not allow horseplay on or under the bed and prohibit jumping on the bed.
- 9) Always use the ladder for entering and leaving the upper bunk.
- 10) Do not use substitute parts. Contact the manufacturer or dealer for replacement parts.
- 11) Use of a night light may provide an added safety precaution for a child using the bunk.
- 12) If the bunk bed will be placed next to a wall, the guard rail that runs the full length of the bed should be placed against the wall to prevent entrapment.
- 13) Always use guard rails on both sides of the upper bunk.
- 14) The use of water or sleep flotation mattresses is prohibited.
- 15) Keep these instructions for future reference.

**STRANGULATION HAZARD**

- 15) Never attach or hang items to any part of the bunk bed that are not designed for use with the bed. For example, but not limited to hooks, belts or jump ropes.

**Warning - On Beds with finials that can be configured as Bunk Beds!**

**Effective on Bunk Beds manufactured on or after March 10<sup>th</sup>, 2008, finials cannot be used.**

**The finials provided with certain beds, which are part of the design of the bed, are to be used only in one of the lower configuration – that is as a Twin, Full, Queen or King configuration.**

**These finials are never to be used in the upper structure in a Bunk Bed configuration.**

**Using the finials in the upper structure of a Bunk Bed will create a strangulation hazard. Never use finials in the upper structure of a Bunk Bed.**

**A flat Mushroom Cap – made to conform to the requirement is provided to take the place of finials in the upper structure in Bunk Bed configurations.**