







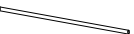

## **Assembly Sheet Top Tent Frame - Top Tent**

Replacement parts can be obtained from any Bolton Furniture authorized dealer

249 Professional Drive, Morrisville, VT  
Phone: 802-888-7974  
Fax: 802-888-3668  
Web Site: [www.boltonfurniture.biz](http://www.boltonfurniture.biz)

## PARTS LIST

NO.	Drawing	Description	Qty.
A		Top Rail	2
B		Posts	4
C		Round Rod	2
D		Round Dowel Rod	2

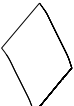
NO.	Drawing	Description	Qty.
E		80mm Hex Bolt	4
F		50mm Hex Bolt	2
G		30mm Wood Screw	2
H		M6 Hex Wrench	1
I		Top Tent	1
J		Top Tent End	2

### **Top Tent Frame Assembly: Two people recommended for this assembly.**

#### **Step 1**

Complete Assembly of Low Loft

#### **Step 2 -**

Open boxes and verify that all parts are included.

#### **Step 3 - Assemble Top Frame**

Insert Round Rod (inserts installed) (C) into Top Tent End (J). Do this for both ends. SEE ILLUSTRATION.

Insert Round Rods w/ Top Tent Ends into pre-drilled holes in Posts (B) 4 places. Make sure threaded insert is facing up aligned with hole in top edge of posts.

Attach Top Rails (A) to top of posts by aligning pre-drilled thru holes to holes in top edge of post. Insert 80 MM Hex Bolt (E) into pre-drilled holes and thread into insert in Round Rod (C). Do this in 4 places. Tighten Hex Bolts using Hex Wrench (H)

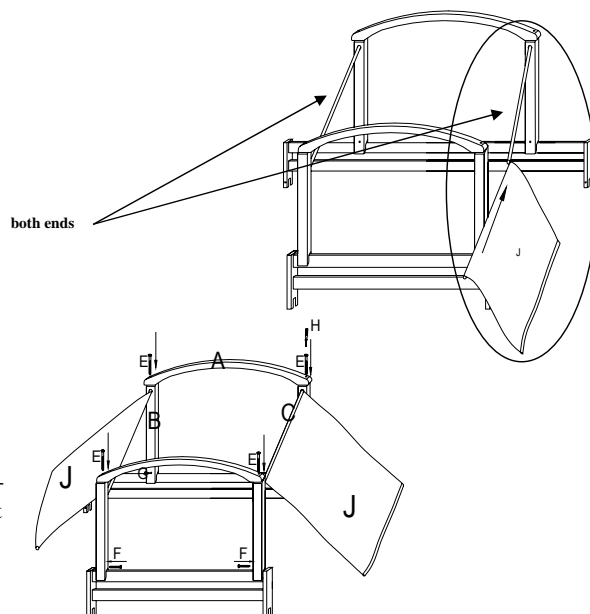

**Step 4 - Attach Frame to front & Back Guardrail**

Using 50 MM Hex Bolt (F), attach front two posts to short guardrail. Tighten using Hex Wrench (H)

Attach Back posts to long guardrail using 30 MM Wood Screws (G). Tighten w/ phillips screwdriver.

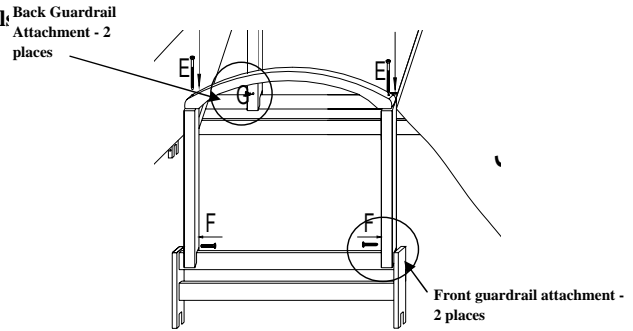

**Step 5 - Attach Top Tent Fabric**

Remove Velcro Male strip from front side of Top Tent Fabric (A). Center the Velcro strip left to right and attach to under front edge of Front Top Rail.

Attach Top Tent (I) to Front Top Rail to Velcro strip and to the Back Top Rail using the Strips.

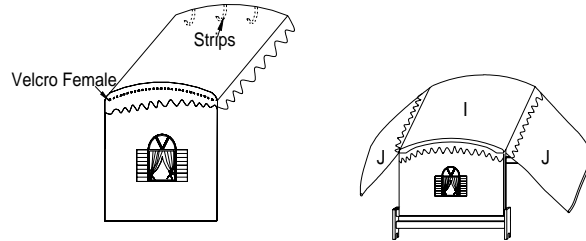
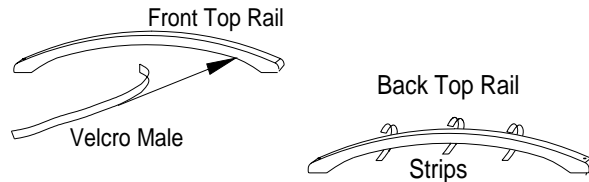

**Step 6 - Insert Round Dowel Rod**

Insert Round Dowel Rod (D) into the loop on ends of Top Tent Ends (J). Lay the Top Tent Ends over bed ends.

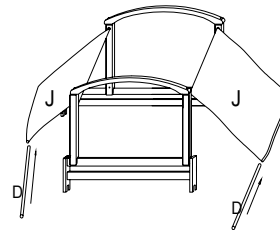

**This completes the assembly of the Top Tent Frame and Top Tent Fabric!**

